

# SAW Components

## BAW/SAW Duplexer

WCDMA Band II

<b>Series/type:</b>	<b>B8004</b>
<b>Ordering code:</b>	<b>B39202B8004P810</b>
<b>Date:</b>	<b>September 02, 2014</b>
<b>Version:</b>	<b>2.0</b>

© EPCOS AG 2015. Reproduction, publication and dissemination of this publication, enclosures hereto and the information contained therein without EPCOS' prior express consent is prohibited.

EPCOS AG is a TDK Group Company.

Data sheet

**Application**

- Low-loss BAW/SAW duplexer for mobile telephone WCDMA Band II systems
- Low insertion attenuation
- Low amplitude ripple
- Usable passband 60 MHz
- Single ended to balanced transformation in Antenna - Rx path
- Impedance transformation 50Ω to 100Ω in Antenna - Rx path

**Features**

- Package size 2.0 x 1.6 mm<sup>2</sup>, max. height 0.45 mm
- RoHS compatible
- Approx. weight 0.0056g
- Package for **Surface Mount Technology (SMT)**
- Ni, gold-plated terminals
- Fully matched by integrated matching network
- **Electrostatic Sensitive Device (ESD)**
- **Moisture Sensitivity Level 3**

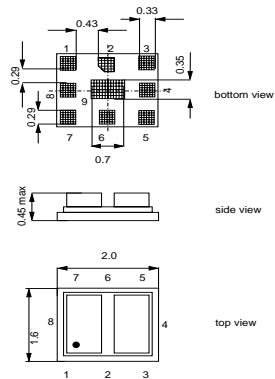
**Pin configuration**

- 3 TX Input
- 1, 8 RX Output (balanced)
- 6 Antenna
- 4, 5, 9 To be grounded
- 2, 7 To be grounded

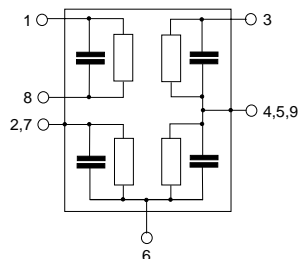

**Data sheet**

**Characteristics**

Temperature range for specification:	T = -20 °C to +85 °C
ANT terminating impedance:	Z <sub>ANT</sub> = 50 Ω
RX differential mode terminating impedance:	Z <sub>RXd</sub> = 100 Ω and matching (refer to page 6)
RX common mode terminating impedance:	Z <sub>RXc</sub> = 25 Ω
TX terminating impedance:	Z <sub>TX</sub> = 50 Ω

Characteristics TX - ANT		min.	typ. @ 25°C	max.	
<b>Center frequency</b>	f <sub>C</sub>	—	1880.0	—	MHz
<b>Maximum insertion attenuation</b>					
@f <sub>Carrier</sub> 1852.4 ... 1907.6 MHz	α <sub>WCDMA</sub> <sup>1)</sup>	—	2.2	3.0	dB
@f <sub>Carrier</sub> 1852.4 ... 1907.6 MHz	α <sub>WCDMA</sub> <sup>1)</sup>	—	2.2	2.5 <sup>3)</sup>	dB
<b>Error Vector Magnitude</b>					
@f <sub>Carrier</sub> 1852.4 ... 1907.6 MHz	EVM <sup>2)</sup>	—	1.1	3.0	%
@f <sub>Carrier</sub> 1852.4 ... 1907.6 MHz	EVM <sup>2)</sup>	—	1.1	2.0 <sup>3)</sup>	%
<b>Input VSWR (TX port)</b>					
1850.0 ... 1910.0 MHz		—	1.5	2.0	
<b>Output VSWR (ANT port)</b>					
1850.0 ... 1910.0 MHz		—	1.7	2.0	
<b>Attenuation</b>					
	α				
10.0 ... 728.0 MHz		30	32	—	dB
728.0 ... 764.0 MHz		30	33	—	dB
869.0 ... 894.0 MHz		30	34	—	dB
1574.0 ... 1577.0 MHz		36	38	—	dB
1577.0 ... 1680.0 MHz		30	38	—	dB
@f <sub>Carrier</sub> 1932.4 ... 1987.6 MHz	α <sub>WCDMA</sub> <sup>1)</sup>	45	50	—	dB
2110.0 ... 2155.0 MHz		35	41	—	dB
2400.0 ... 2500.0 MHz		23	27	—	dB
3690.0 ... 3830.0 MHz		20	25	—	dB
5150.0 ... 5350.0 MHz		16	21	—	dB
5540.0 ... 5860.0 MHz		14	17	—	dB

<sup>1)</sup> Attenuation of WCDMA signal ("Powertransferfunction"). Please refer to annotation on page (6).

<sup>2)</sup> Error Vector Magnitude (EVM) based on definition given in 3GPP TS 25.141.

<sup>3)</sup> Valid for room temperature 25 °C

**Data sheet**

**Characteristics**

Temperature range for specification:	T = -20 °C to +85 °C
ANT terminating impedance:	Z <sub>ANT</sub> = 50 Ω
RX differential mode terminating impedance:	Z <sub>RXd</sub> = 100 Ω and matching (refer to page 6)
RX common mode terminating impedance:	Z <sub>RXc</sub> = 25 Ω
TX terminating impedance:	Z <sub>TX</sub> = 50 Ω

Characteristics ANT - RX		min.	typ. @ 25°C	max.	
<b>Center frequency</b>	f <sub>C</sub>	—	1960.0	—	MHz
<b>Maximum insertion attenuation</b>					
@f <sub>Carrier</sub>	1932.4 ... 1987.6MHz α <sub>WCDMA</sub> <sup>1)</sup>	—	2.5	3.7	dB
@f <sub>Carrier</sub>	1932.4 ... 1987.6MHz α <sub>WCDMA</sub> <sup>1)</sup>	—	2.5	3.0 <sup>2)</sup>	dB
<b>Error Vector Magnitude</b>					
@f <sub>Carrier</sub>	1932.4 ... 1987.6MHz EVM <sup>3)</sup>	—	1.6	6.0	%
@f <sub>Carrier</sub>	1932.4 ... 1987.6MHz EVM <sup>3)</sup>	—	1.6	3.5 <sup>5)</sup>	%
@f <sub>Carrier</sub>	1932.4 ... 1987.6MHz EVM <sup>3)</sup>	—	1.6	3.2 <sup>4)</sup>	%
<b>Input VSWR (ANT port)</b>					
	1930.0 ... 1990.0MHz	—	2.0	2.6	
	1935.0 ... 1990.0MHz	—	1.5	2.0 <sup>5)</sup>	
<b>Output VSWR (RX port)</b>					
	1930.0 ... 1990.0MHz	—	1.8	2.4	
	1930.0 ... 1990.0MHz	—	1.8	2.0 <sup>5)</sup>	
<b>Attenuation</b>					
	10.0 ... 1765.0MHz α	30	49	—	dB
	1835.0 ... 1850.0MHz	30	52	—	dB
@f <sub>Carrier</sub>	1852.4 ... 1907.6MHz α <sub>WCDMA</sub> <sup>1)</sup>	45	56	—	dB
	2025.0 ... 2050.0MHz	10	27	—	dB
	2050.0 ... 2075.0MHz	25	31	—	dB
	2400.0 ... 2484.0MHz	30	52	—	dB
	2810.0 ... 2910.0MHz	30	56	—	dB
	3775.0 ... 3905.0MHz	30	60	—	dB
	5625.0 ... 5815.0MHz	30	63	—	dB
	2075.0 ... 6000.0MHz	30	35	—	dB

1) Attenuation of WCDMA signal ("Powertransferfunction"). Please refer to annotation on page (6).

2) Valid for the temperature range from 0 °C to 85 °C.

3) Error Vector Magnitude (EVM) based on definition given in 3GPP TS 25.141.

4) Valid for room temperature 25 °C.

5) Valid for the temperature range from 25 °C to 85 °C.

**Data sheet**

**Characteristics**

Temperature range for specification:	T	= -20 °C to +85 °C
ANT terminating impedance:	Z <sub>ANT</sub>	= 50 Ω
RX differential mode terminating impedance:	Z <sub>RXd</sub>	= 100 Ω and matching (refer to page 6)
RX common mode terminating impedance:	Z <sub>RXc</sub>	= 25 Ω
TX terminating impedance:	Z <sub>TX</sub>	= 50 Ω

Characteristics ANT - RX	min.	typ. @ 25 °C	max.	
<b>Common Mode Rejection Ratio CMRR</b> 1930.0 ... 1990.0 MHz	21 <sup>1)</sup>	26	—	dB
<b>IMD Product Level Limits<sup>2)</sup></b> <b>at f<sub>TX</sub>=1880MHz, f<sub>RX</sub>=1960MHz</b>				
Blocker 1                      80.0 MHz	—	-94	—	dBm
Blocker 2                      1800.0 MHz	—	-115	—	dBm
Blocker 3                      3840.0 MHz	—	-110	—	dBm

- <sup>1)</sup> A combination of 10° phase balance and 1dB amplitude balance corresponds to 19.6 dB CMRR  
<sup>2)</sup> IMD product level limits for power levels P<sub>TX</sub>=21.5dBm (antenna port output power) and P<sub>Blocker</sub>=-15dBm (antenna port input power)

Characteristics TX - RX	min.	typ. @ 25 °C	max.	
<b>Isolation</b>				
@f <sub>Carrier</sub> 1852.4 ... 1907.6 MHz α <sub>WCDMA</sub> <sup>1)</sup>	50	57	—	dB
@f <sub>Carrier</sub> 1852.4 ... 1907.6 MHz α <sub>WCDMA</sub> <sup>1) 2)</sup>	53	57	—	dB
@f <sub>Carrier</sub> 1932.4 ... 1987.6 MHz α <sub>WCDMA</sub> <sup>1)</sup>	46	52	—	dB

- <sup>1)</sup> Attenuation of WCDMA signal ("Powertransferfunction"). Please refer to annotation on page (6).  
<sup>2)</sup> Valid for the temperature range from -20 °C to +25 °C.

Data sheet

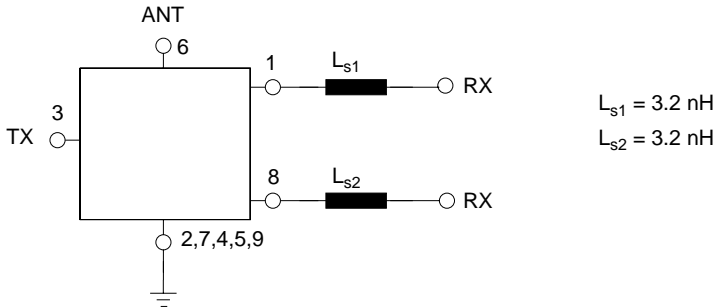
**Matching network** (element values depend on PCB layout)

**Maximum ratings**

Operable temperature range <sup>1)</sup>	T	-30/+85	°C	machine model, 10 pulses source and load impedance 50 Ω } continuous wave T = 55° C, 50.000 h
Storage temperature range	T <sub>stg</sub>	-40/+85	°C	
DC voltage	V <sub>DC</sub>	5.0	V	
ESD voltage	V <sub>ESD</sub>	50 <sup>2)</sup>	V	
Input power at 1850.0 ... 1910.0 MHz	P <sub>IN</sub>	29	dBm	
elsewhere		10	dBm	

1) Defines the temperature range in which the BAW / SAW device keeps its typical characteristics, however the specification values are not valid for the extended range.

2) acc. to JESD22-A115B (machine model), 10 negative & 10 positive pulses.

**Annotation for characteristics section**

Attenuation of WCDMA signal ("Powertransferfunction",  $\alpha_{\text{WCDMA}}$ ) is determined by

$$\int_{-\infty}^{\infty} |S_{ds21}(f)H_{\text{RRC}}(f - f_{\text{Carrier}})|^2 df$$

$f_{\text{Carrier}}$  according to 3GPP TS 25.101 (e.g. for WCDMA Band 2 Passband,  $f_{\text{Carrier}}$  ranges from 1852.4 MHz (lowest Tx channel) to 1907.6 MHz (highest Tx channel)).  $H_{\text{RRC}}(f)$  is the transfer function of the root-raised cosine transmit pulse shaping filter according to 3GPP TS 25.101 with the following normalization:

$$\int_{-\infty}^{\infty} |H_{\text{RRC}}(f)|^2 df = 1$$

Data sheet



Frequency Response TX-ANT (PTF)

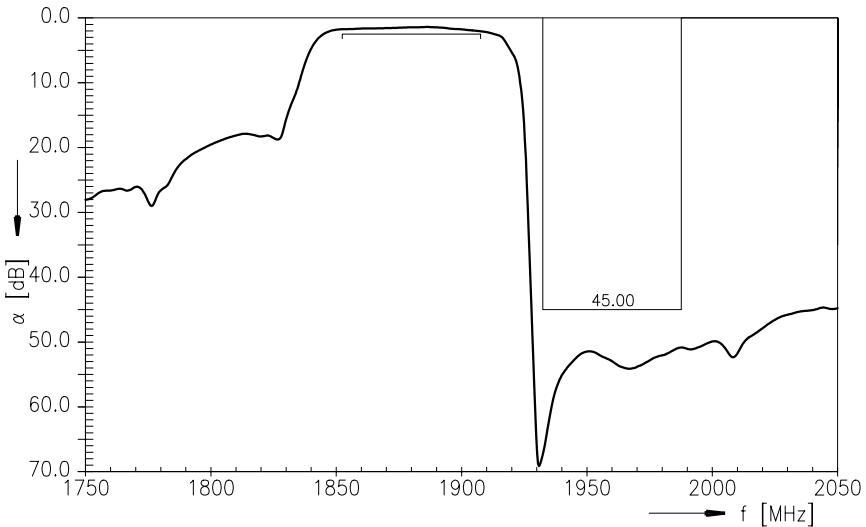

Frequency Response TX-ANT (wideband)

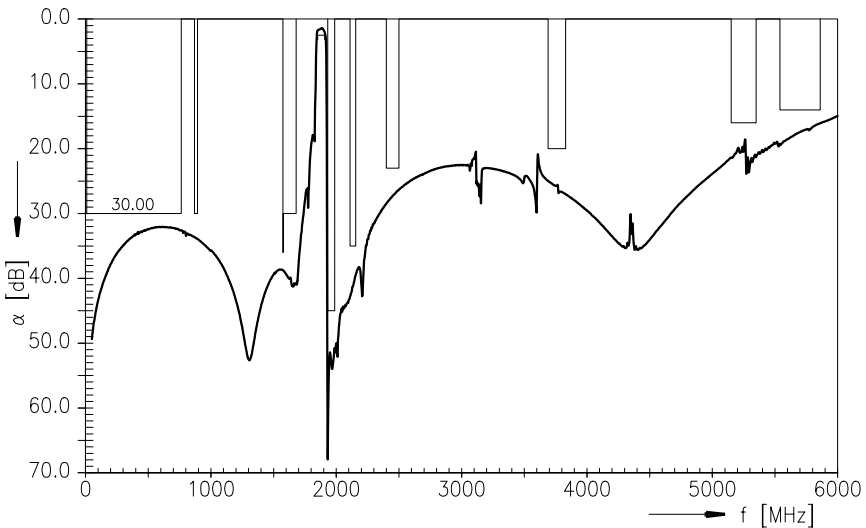

Data sheet



**Frequency Response ANT-RX (PTF), also spec lines for CW plotted**

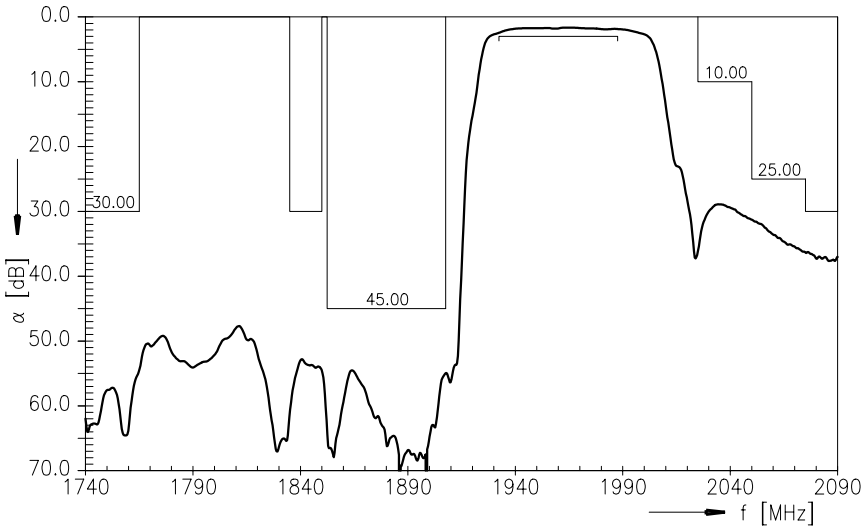

**Frequency Response ANT-RX (wideband)**

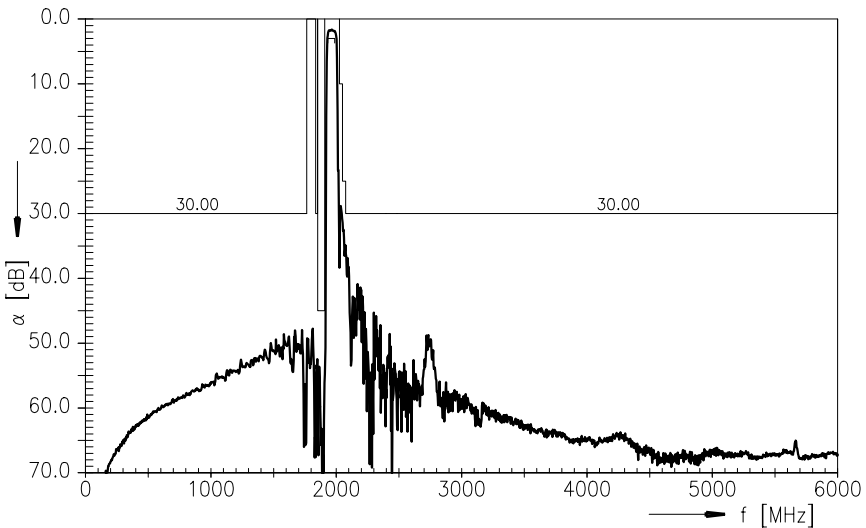



Data sheet



**Frequency Response TX-ANT Passband (PTF)**

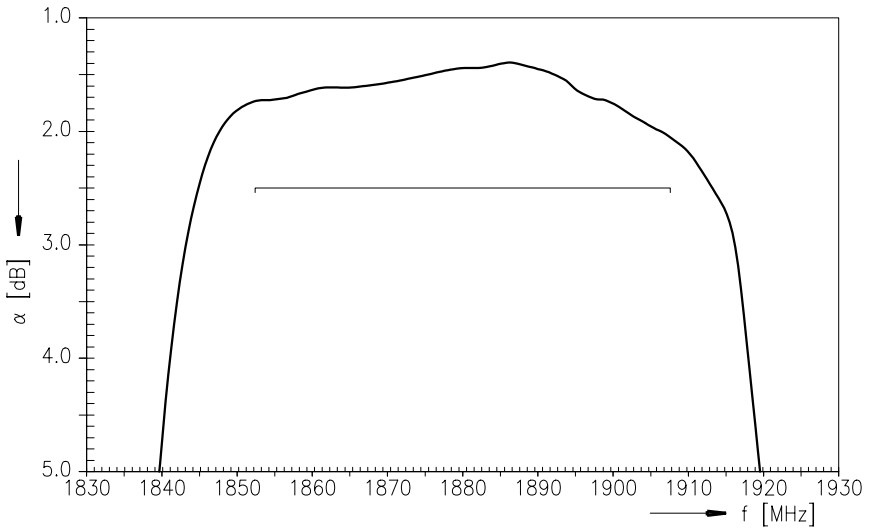

**Frequency Response ANT-RX Passband (PTF)**

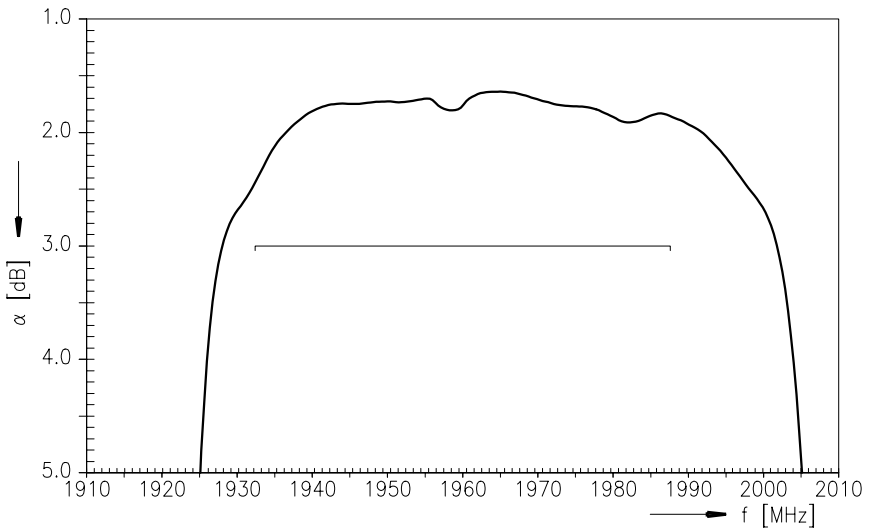

Data sheet



Frequency Response TX-RX (PTF)

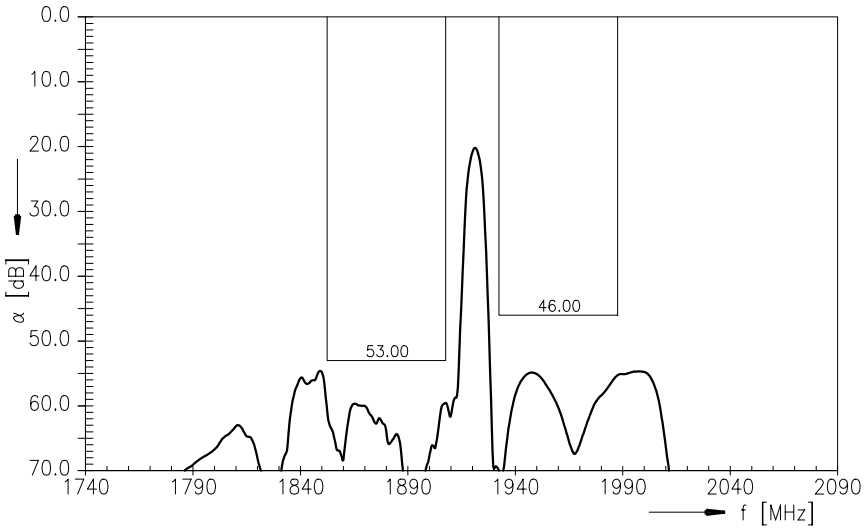

Data sheet



**VSWR TX-port**

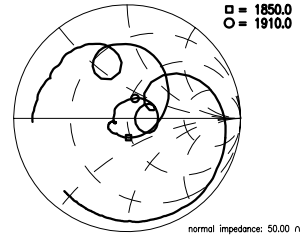
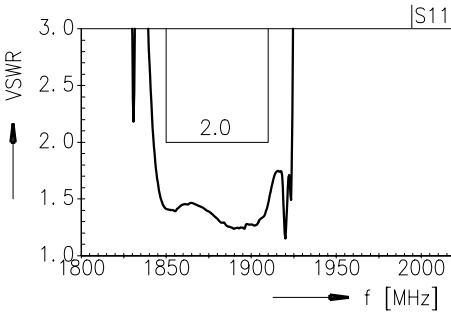

**VSWR RX-port (differential mode)**

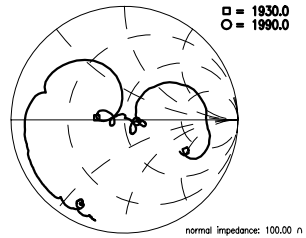
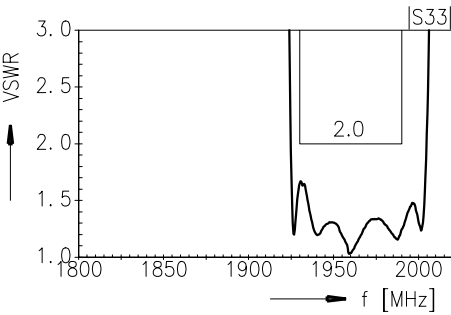

**VSWR ANT-port**

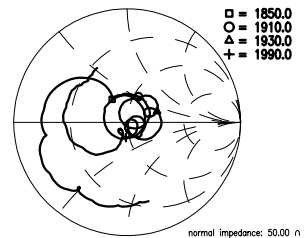
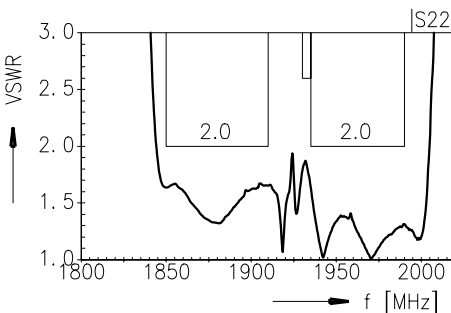

<b>SAW Components</b>	<b>B8004</b>
<b>BAW/SAW Duplexer</b>	<b>1880.0 / 1960.0 MHz</b>

Data sheet



<b>Type</b>	B8004
<b>Ordering code</b>	B39202B8004P810
<b>Marking and package</b>	C61157-A8-A81
<b>Packaging</b>	F61074-V8247-Z000
<b>Date codes</b>	L_1126
<b>S-parameters</b>	B8004_NB_UN.s4p (unmatched, nearby) B8004_WB_UN.s4p (unmatched, wideband) see file header for port/pin assignment table
<b>Soldering profile</b>	S_6001
<b>RoHS compatible</b>	RoHS-compatible means that products are compatible with the requirements according to Art. 4 (substance restrictions) of Directive 2011/65/EU of the European Parliament and of the Council of June 8 <sup>th</sup> , 2011, on the restriction of the use of certain hazardous substances in electrical and electronic equipment ("Directive") with due regard to the application of exemptions as per Annex III of the Directive in certain cases.
<b>Moldability</b>	Before using in overmolding environment, please contact your EPCOS sales office.
<b>Matching coils</b>	See Inductor pdf-catalog <a href="http://www.tdk.co.jp/tefe02/coil.htm#aname1">http://www.tdk.co.jp/tefe02/coil.htm#aname1</a> and Data Library for circuit simulation <a href="http://www.tdk.co.jp/etvcl/index.htm">http://www.tdk.co.jp/etvcl/index.htm</a>

For further information please contact your local EPCOS sales office or visit our webpage at [www.epcos.com](http://www.epcos.com).

**Published by EPCOS AG**  
**Systems, Acoustics, Waves Business Group**  
**P.O. Box 80 17 09, 81617 Munich, GERMANY**

© EPCOS AG 2014. This brochure replaces the previous edition.

For questions on technology, prices and delivery please contact the Sales Offices of EPCOS AG or the international Representatives.

Due to technical requirements components may contain dangerous substances. For information on the type in question please also contact one of our Sales Offices.

## Important notes

The following applies to all products named in this publication:

1. Some parts of this publication contain **statements about the suitability of our products for certain areas of application**. These statements are based on our knowledge of typical requirements that are often placed on our products in the areas of application concerned. We nevertheless expressly point out **that such statements cannot be regarded as binding statements about the suitability of our products for a particular customer application**. As a rule, EPCOS is either unfamiliar with individual customer applications or less familiar with them than the customers themselves. For these reasons, it is always ultimately incumbent on the customer to check and decide whether an EPCOS product with the properties described in the product specification is suitable for use in a particular customer application.
2. We also point out that **in individual cases, a malfunction of electronic components or failure before the end of their usual service life cannot be completely ruled out in the current state of the art, even if they are operated as specified**. In customer applications requiring a very high level of operational safety and especially in customer applications in which the malfunction or failure of an electronic component could endanger human life or health (e.g. in accident prevention or life-saving systems), it must therefore be ensured by means of suitable design of the customer application or other action taken by the customer (e.g. installation of protective circuitry or redundancy) that no injury or damage is sustained by third parties in the event of malfunction or failure of an electronic component.
3. **The warnings, cautions and product-specific notes must be observed.**
4. In order to satisfy certain technical requirements, **some of the products described in this publication may contain substances subject to restrictions in certain jurisdictions (e.g. because they are classed as hazardous)**. Useful information on this will be found in our Material Data Sheets on the Internet ([www.epcos.com/material](http://www.epcos.com/material)). Should you have any more detailed questions, please contact our sales offices.
5. We constantly strive to improve our products. Consequently, **the products described in this publication may change from time to time**. The same is true of the corresponding product specifications. Please check therefore to what extent product descriptions and specifications contained in this publication are still applicable before or when you place an order. We also **reserve the right to discontinue production and delivery of products**. Consequently, we cannot guarantee that all products named in this publication will always be available. The aforementioned does not apply in the case of individual agreements deviating from the foregoing for customer-specific products.
6. Unless otherwise agreed in individual contracts, **all orders are subject to the current version of the "General Terms of Delivery for Products and Services in the Electrical Industry" published by the German Electrical and Electronics Industry Association (ZVEI)**.
7. The trade names EPCOS, BAOKE, Alu-X, CeraDiode, CeraLink, CeraPlas, CSMP, CSSP, CTVS, DeltaCap, DigiSiMic, DSSP, FilterCap, FormFit, MiniBlue, MiniCell, MKD, MKK, MLSC, MotorCap, PCC, PhaseCap, PhaseCube, PhaseMod, PhiCap, SIFERRIT, SIFI, SIKOREL, SilverCap, SIMDAD, SiMic, SIMID, SineFormer, SIOV, SIP5D, SIP5K, TFAP, ThermoFuse, WindCap are **trademarks registered or pending** in Europe and in other countries. Further information will be found on the Internet at [www.epcos.com/trademarks](http://www.epcos.com/trademarks).